

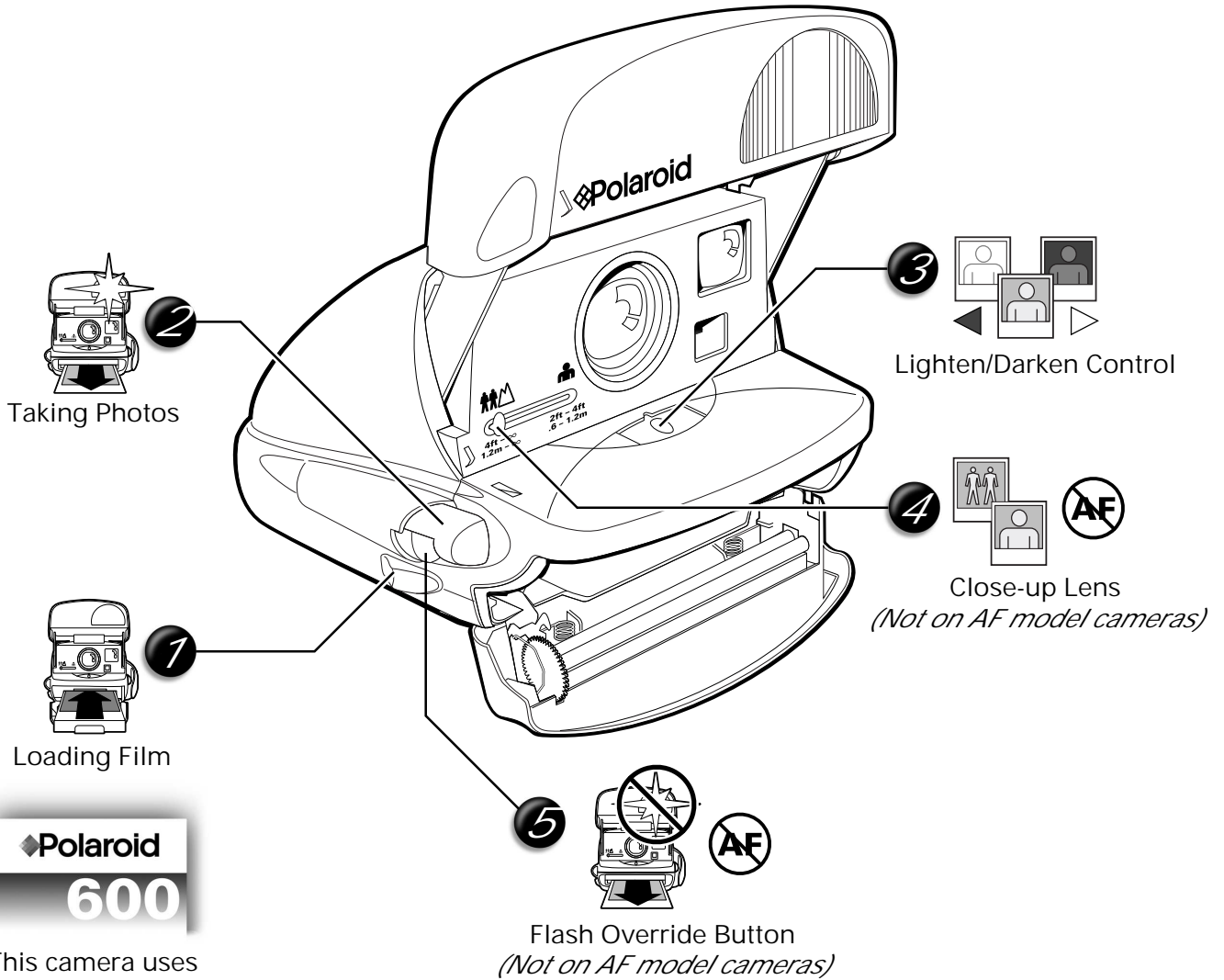

www.polaroid.com



Questions? Need Help?
Contact Polaroid Customer Care Center
Toll Free at: 1-800-343-5000
8am - 6 pm EST Mon - Fri (USA only)



This camera uses Polaroid 600 series film. Each pack of film contains 10 photos.

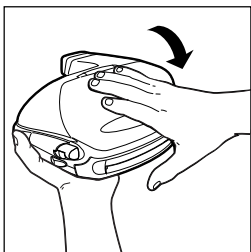

Snap the camera shut when not in use.

| | |
|-----------------------------|-------------------------------------|
| AF AF Model Cameras: | Non-AF Non-AF Model Cameras: |
| 636 AF | 637 |
| OneStep AF | OneStep |
| OneStep AF SE | OneStep Express |
| 600 AF | 600 Extreme |
| | 600 CL |
| | Cool Cam |
| | JobPro 2 |
| | 600 Business Edition 2 |

1 Loading Film

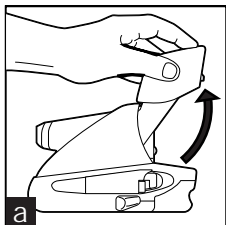
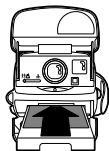

a Pull up the flash unit and snap it into place.

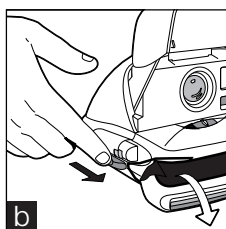

b Open the film door.

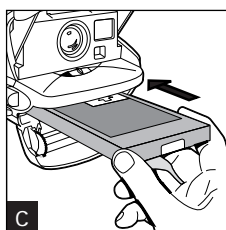

c Insert the film pack as shown. Hold the film pack by the edges. Push the film pack in until a "click" is heard.

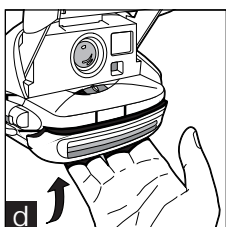

d Close the film door.

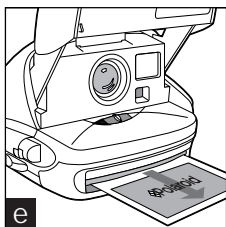

e The camera ejects the paper film cover.

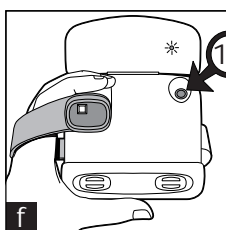

f Check the picture counter on the back of the camera. The number inside the window shows you how many photos are left in a film pack. A new pack of film contains 10 photos.

2 Taking a Photo

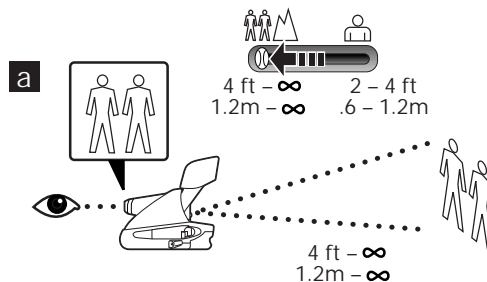

a Position your subject(s) 4-8 feet from the camera (normal lens setting). Frame your subject(s) in the viewfinder.

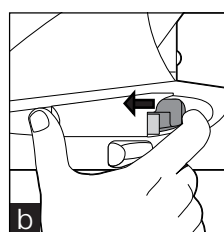

b Hold the camera still and press the shutter button.

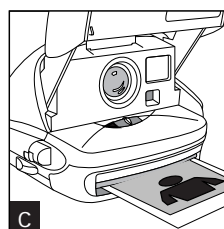

c The photo automatically ejects.

3 Lighten/Darken Control



Use this feature to retake a photo that was too light or too dark. Always return the control to the normal position after using.

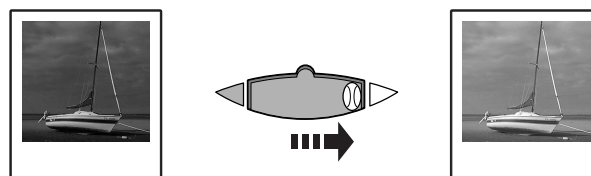

To lighten a photo that is too dark, slide the lighten/darken control to the right. Retake the photo.

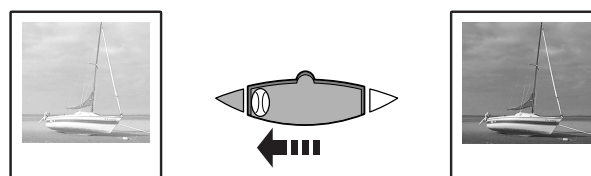

To darken a photo that is too light, slide the lighten/darken control to the left. Retake the photo.

4

Close-up Lens (Not on AF model cameras)



a

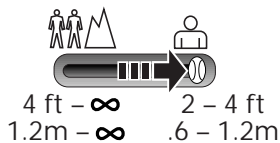

a To take a close-up photo, slide the close-up lens lever to the right.

b

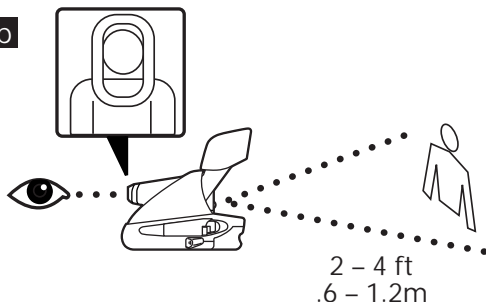

b Position your subject 2 - 4 feet from the camera. Frame your subject in the oval area of the viewfinder. Press the shutter button.

5

Flash Override Button (Not on AF model cameras)



The flash override button allows you to take a photo without the flash. Use this feature when shooting metallic or shiny surfaces, or when shooting a subject through glass.

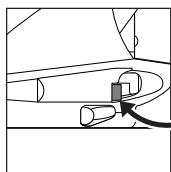
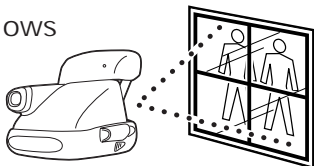

Flash Override Button

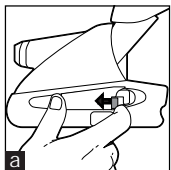

a Frame your subject. Hold the camera still and press the flash override button.

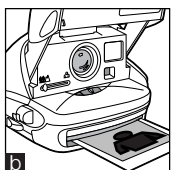

b The photo automatically ejects.

Developing Photos

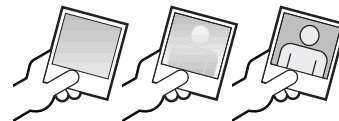

Developing photos are fragile.

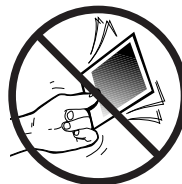

Do not shake



Do not bend

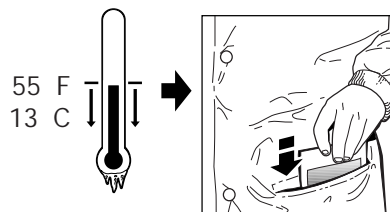

If the temperature is below 55 F (13 C) place the developing photo in a warm location, such as your pocket.

Camera Maintenance

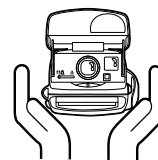

Do not touch the camera lens.

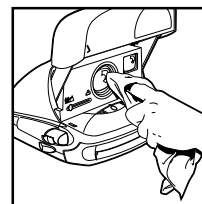

Clean the camera lens with a soft, lint-free cloth.

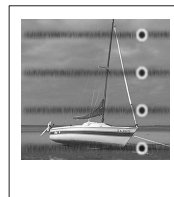

If spots or banding appears on photos, the camera may have dirty developer rollers.

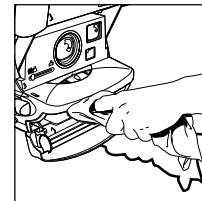
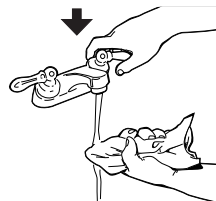

To clean the developer rollers, dampen a clean cloth with tap water. Open the film door and thoroughly clean the rollers. If film is in the camera, clean the rollers in a dimly-lit area.